

SGHF2800D 19V-39V Input 15W output DC/DC converters

Space application

Design

SGHF2800S and SGHF2800D isolated hybrid DC/DC converter series is a design, based on European components, made to keep robust performance in the harsh space environment. The design complies with the derating rules specified in ECSS-Q-ST-30-11C, up to 80°C, and the qualification and production meet the generic procurement requirements for hybrids ECSS-Q-ST-60-05C.

The converter is switching at a fix frequency, in the range 360kHz-420kHz, and take the advantages of a magnetic feedback (no optocoupler used) resulting in high radiation tolerance levels.

The metal sealed package is designed to dissipate the power reducing the temperature stress on junctions of silicon devices. The case is also flanged to achieve robustness against vibrations.

The design documentation is including worst case, part stress analysis and reliability analysis.



Features

- Input voltage 19V-39V
- Input fault tolerance 50V
- Operating temperature range: -40°C ÷ +80°C (15W @80°C, within ECSS-Q.ST-30-11C derating rules)
- ON/OFF capability
- Input under-voltage protection with activation hysteresis
- Output over-voltage latching protection
- Overcurrent/short circuit protection
- Radiation tolerance¹:
 - TID: 50Krad
 - SEE 60 MeV-cm²/mg
- Magnetic coupled feedback
- Export restriction free

¹ Radiation tolerance based on components screening and unit level analysis.

Block diagram

ARC-SGHF2800D:

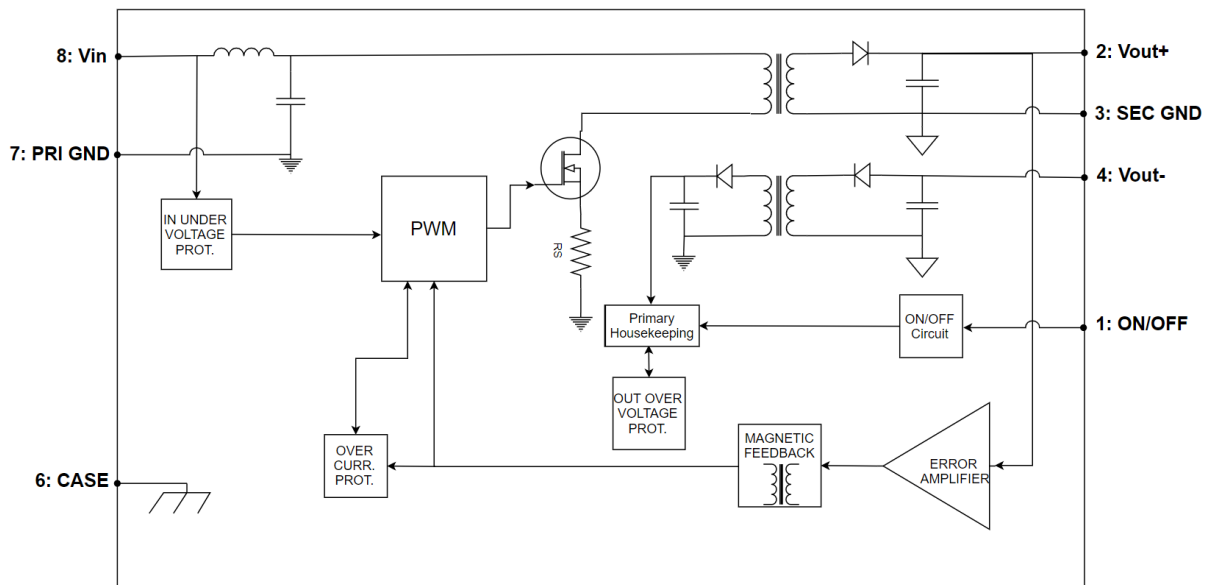

Electrical characteristics and performances

Performances in the range $-40^{\circ}\text{C} \div +80^{\circ}\text{C}$, input voltage 28V, full load; unless otherwise specified.

		SGHF2805D			SGHF2812D			
Parameter	Description	Min	Typ	Max	Min	Typ	Max	Unit
Input Section								
Operating input voltage	ECSS-Q-ST-30-11C compliant	19	28	39	19	28	39	V
Fault input voltage tolerance	Continuous	-	-	50	-	-	50	V
Under voltage lockout	ON threshold	15.8	-	16.2	15.8	-	16.2	V
	OFF threshold	14.4	-	15.0	14.4	-	15.0	V
Ripple current	20Hz to 10Mhz	-	100	120	-	100	120	mApp
No load current	On condition no load connected @25°C	-	37	-	-	40	-	mA

		SGHF2805D			SGHF2812D			
Parameter	Description	Min	Typ	Max	Min	Typ	Max	Unit
OFF condition current		-	2	4	-	2	4	mA
Output Section								
Voltage positive output	-40°C ÷ +80°C	4.92	5.00	5.08	11.90	12.00	12.10	V
Power	-40°C ÷ +80°C (ECSS-Q-ST-30-11C compliant)	0	-	15	0	-	15	W
Current positive output	-40°C ÷ +80°C (ECSS-Q-ST-30-11C compliant)	0	-	3	0	-	1.25	A
Current negative output	-40°C ÷ +80°C (ECSS-Q-ST-30-11C compliant)	0	-	1.5	0	-	0.62	A
Ripple voltage	Switching frequency	-	70	90	-	60	80	mVpp
Spikes	High frequency	-	-	100	-	-	100	mVpp
Line regulation (pos. out)	19V to 39V input	-	1	5	-	1	5	mV
Load regulation (pos. out)	0A to 3A load	-	10	20	-	10	20	mV
Load step positive output	Half to full load	-	80	100	-	60	80	mV
	Recovery time	-	300	400	-	250	300	µsec
Start up overshoot pos. out.	0V to 28V	-	-	100	-	-	400	mV
Start up rise time	0V to nominal output voltage	-	-	20	-	-	20	msec
Load fault power dissipation	Overload	-	-	8	-	-	8	W
Functions								
Inhibit	OFF (PIN 1 grounded to PRI_GND)	0	-	1.5	0	-	1.5	V
	ON (high impedance on PIN1)	Open collector or unconnected			Open collector or unconnected			-
Overvoltage Protection	Activation above nominal output voltage (load positive output from 1.5W to 15W)	110	-	125	110	-	125	%
Other data								
Efficiency	@ 25°C	75			80			%
Capacitive load (per output)		-	-	300	-	-	100	µF
Switching frequency	Fix frequency	360	-	420	360	-	420	kHz
Isolation	500V DC (case temperature 25 °C)	100	-	-	100	-	-	MΩ
Storage temperature		-65	-	155	-65	-	155	°C
Soldering temperature		-	-	300	-	-	300	°C
Weight		-	-	40	-	-	40	g

Typical input ripple current @ switching frequency;
28V In; 15W Out (50m amp/div)

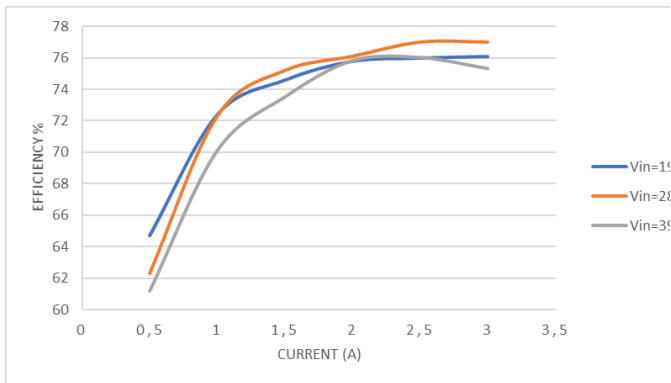
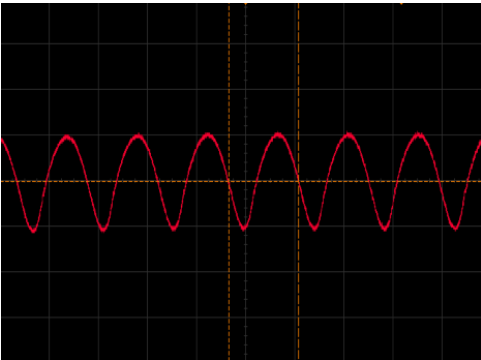

Efficiency dual out 5V @ 25°C

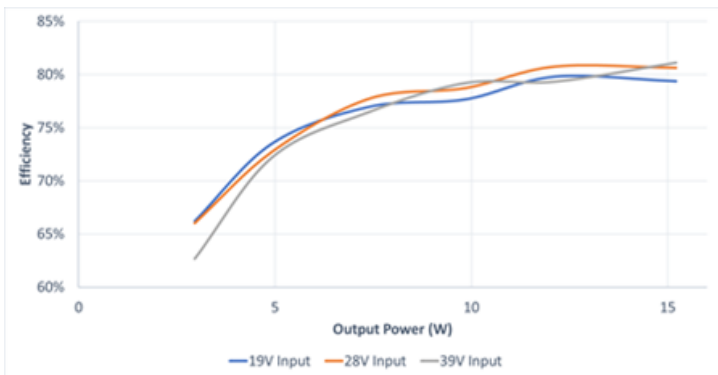

Efficiency dual out 12V @ 25°C

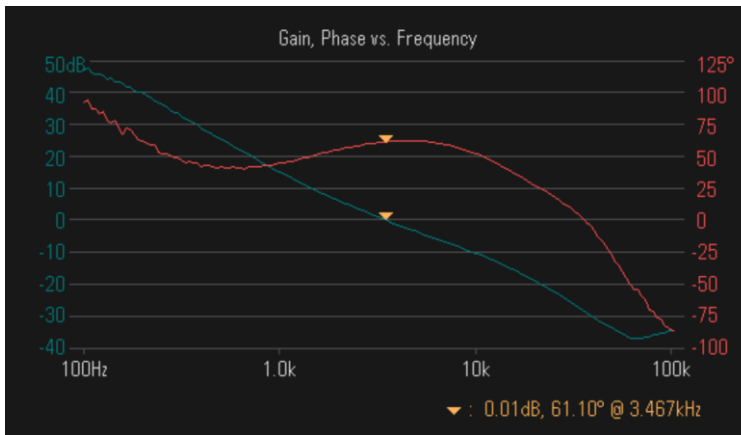

Stability @5W output

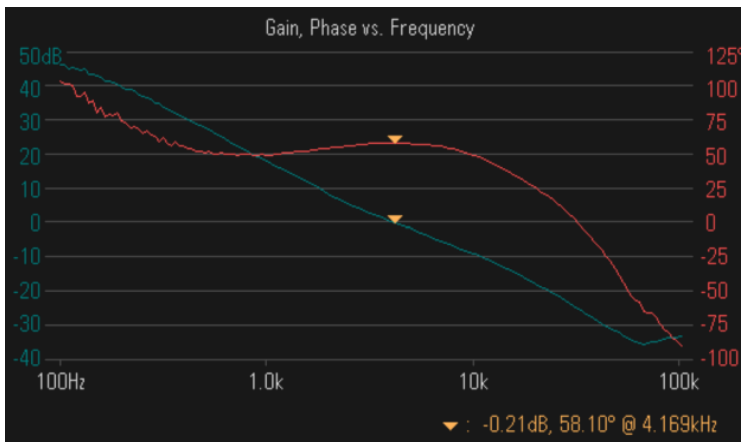

Stability @10W output

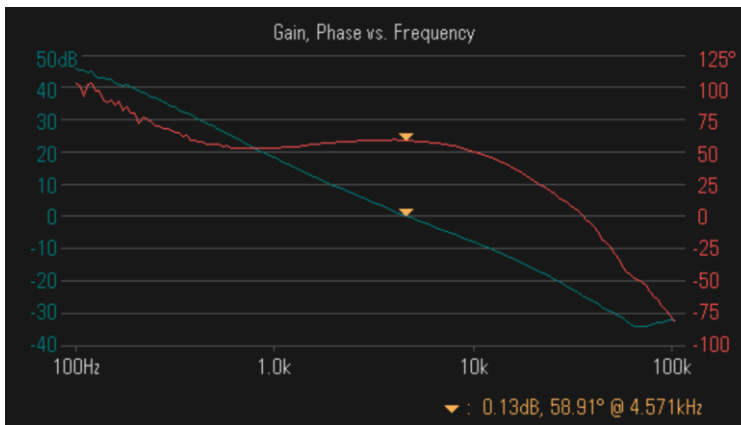

Stability @10W output

Case and pin out

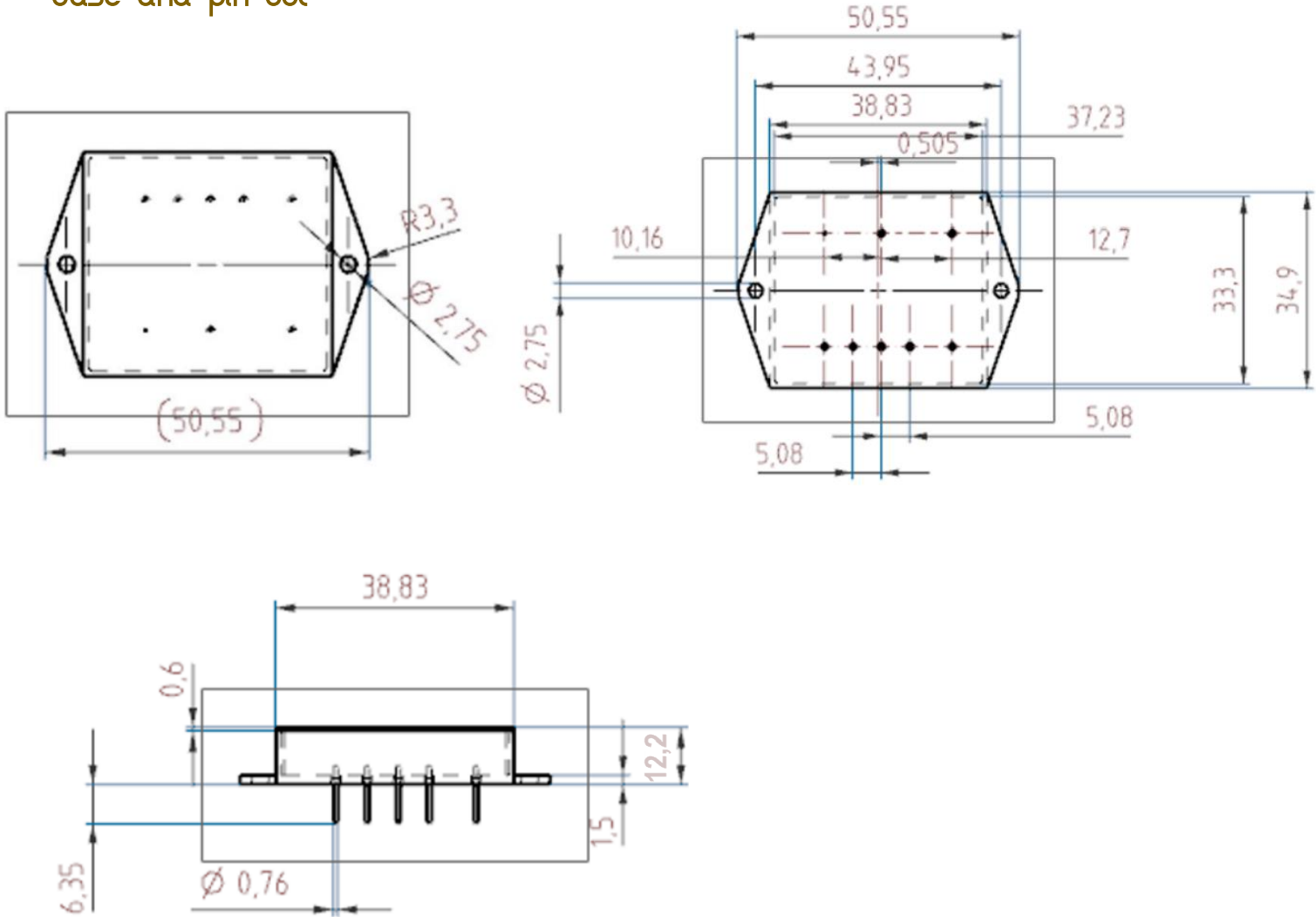

Case Dimension in mm

Tolerance: +/-0.13 for three decimal places; +/-0.3 for two decimal places

Soldering

Heat from may damage the device. Solder pins individually with heat application not exceeding 300°C for 10 seconds.

Materials:

Header: Steel/Nickel/Gold

Cover: Steel/Nickel/Gold

Pins: Iron-Nickel Alloy 52/Gold compression glass seal; Gold Plating of 1.27-3.81 µm included in pin diameter

Seal Hole: 2 ±0.05 glass

PIN number	Function
1	ON/OFF
2	+Vout
3	SEC_GND
4	-Vout (or NC is case of single output)
5	OV ERROR SIGNAL
6	CASE
7	PRI_GND
8	Vin

